



Electric actuators

for zone valves

SFA21/18
SFA71/18

- SFA21/18 AC 230 V operating voltage, 2-position control
- SFA71/18 AC 24 V operating voltage, 2-position control
- Spring return
- 40 s run-time
- 105N positioning force
- For direct mounting with union nut (no tools required)
- Integral 1.8 m connecting cable
- Ergonomically designed manual adjuster
- Auxiliary switch, type ASC2.1/18 AC 250 V / 2 (1) A

Application

The SFA21/18 and SFA71/18 actuators are used in conjunction with zone valves VV...46... and VX...46..., primarily in heating, ventilation, air conditioning and refrigeration systems for water-based control of hot water and cold water.

- Field of application in accordance with IEC 721-3-3 Class 3K3
- Ambient temperatures: +1 ... +50 °C
- Temperature of medium in the connected valve: +1 ... +110 °C

Functions

The electric actuator requires an on/off controller (thermostat) to control the valve. If the temperature of the medium deviates from the setpoint, the controller output signal causes the actuator to drive the valve open. When the temperature of the medium reaches the setpoint, the control signal is cut off and the valve closes again.

Auxiliary switch

If required, the actuators can be fitted with an optional auxiliary switch. The switch contact closes with a stroke of approximately 50%. At 0%, the contact is open.

Types

Type	Operating voltage	Run-time	Control	Connection	Accessories
SFA21/18	AC 230 V	40 s	2-position	1.8 m cable	ASC2.1/18 auxiliary switch
SFA71/18	AC 24 V				

Accessories

Type	Description	Switching point	Switching capacity	Connection
ASC2.1/18	Auxiliary switch open/closed	At approx. 50% stroke	AC 250 V / 1 A	1.8m cable

Ordering

When ordering please specify the quantity, product name and type code.

*Example: 2 electric actuators, type SFA71/18 and
2 auxiliary switches, type ASC2.1/18*

Compatibility

Zone valves

VVI46... with internal thread

VVS46... with solder connection

Valve type	Valve type	k_{vs} [m ³ /h]	Nominal pressure PN [bar]	Data sheet
VVI46.15, VVS46.15	Two-port valves	2.0	PN16	N4842
VVI46.20, VVS46.20		3.5		
VVI46.25, VVS46.25		5.0		
VXI46.15, VXS46.15	Three-port valves	2.0		
VXI46.20, VXS46.20		3.5		
VXI46.25, VXS46.25		5.0		

Design

The valve is opened electrically by the actuator and closed by spring force. It incorporates a synchronous motor, a gear mechanism and a return spring. The electric motor is overload-resistant and anti-locking, so that continuous operation is possible. The maximum stroke is limited mechanically (valve seat). The closing motion, by contrast, includes an overrun for the gear mechanism. This protects the gear mechanism from mechanical shock and increases service life.

The valve is connected by an 1.8 m cable, which is an integral part of the actuator.

Manual adjustment

The valve can be opened manually by use of a lever on the actuator. When the valve is approximately 90% open this locks into position. When electrical operation is resumed, the locking mechanism is released automatically.

Operation

Opening the valve manually

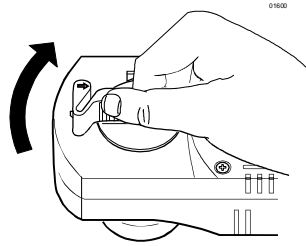

Locking the lever into position at a valve opening of approx. 90%

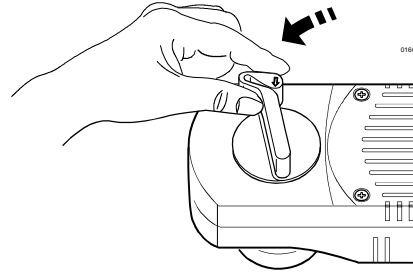

Releasing the lever manually

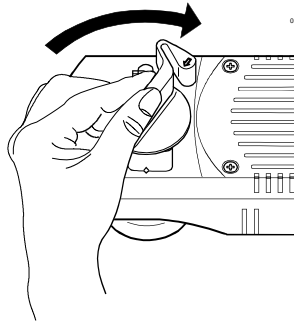

Rotate lever as far as the mechanical stop, and release.

Accessories

ASC2.1/18 auxiliary switch

The optional auxiliary switch can be fitted to the actuator with two screws.

It switches at a stroke of approx. 50%.

- Valve actuator de-energized:
→ Auxiliary switch open
- Voltage applied to valve actuator:
→ Auxiliary switch closed (from approx. 50 % stroke)
- Manual adjuster locked into position
(approx. 90% stroke):
→ Auxiliary switch closed

See "Technical data" for further information on the auxiliary switch.

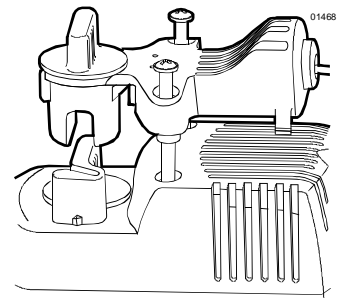

Notes

Engineering

The admissible temperatures (see "Application" and "Technical data") must be observed.

Electrical connection



- The actuator may be operated only with alternating current (AC 230 V for SFA21/18 and AC 24V for SFA71/18)
- **Phase cut and pulse-width-modulated signals are not suitable.**
- Recommended number of opening/closing operations: approx. 50 per day, with 200 heating or cooling days

Mounting

The mounting instructions are printed on the product packaging.

Orientation

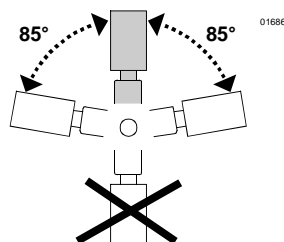

Commissioning

When commissioning the system, check the wiring and functioning of the actuator and of the auxiliary switch, if fitted.

Maintenance

- The actuators require no maintenance.
- In the event of a fault, the actuator can be replaced without removing the valve. The operating voltage must be switched off during this process.
- The actuators cannot be repaired.

Disposal

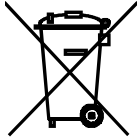

The controller includes electrical components and must not be disposed of as domestic waste.

Current local legislation must be observed.

Warranty

The technical data given for these applications is valid only when the valves are used with the actuators described under "Compatibility".

The use of type SFA... actuators with third-party valves invalidates any warranty offered by Siemens Building Technologies / HVAC Products.

Technical data

		SFA21/18	SFA71/18
Power supply	Operating voltage	AC 230 V	AC 24 V
	Voltage tolerance	-15 / +10 %	
	Frequency	50 Hz	
	Max. power consumption	9.8 VA	
	Fuse protection for incoming cable	Max. 3 A (external)	
Control	Control signal	On/off via temperature controller <i>Phase cut and pulse-width-modulated signals are not suitable.</i>	
	Max. no. of opening/closing operations	Recommended: approx. 10 000 / year (equivalent to approx. 50 per day)	
Operating data	Manual adjustment	0 ... 90 %	
	Position with de-energized actuator Two-port valve (VVI46...) Three-port valve (VXVI46...)	A → AB closed AB → A closed	
	Positioning time	30 ... 50 s (opened by motor, closed by spring force)	
	Positioning force	105N	
Electrical connection	Connecting cable (integral)	2-core, 1800 mm 18 AWG (0.96 mm ²)	
General ambient conditions	Admissible temperature of medium in the connected valve:	+1 ... +110 °C	
	Operation Environmental conditions Temperature Humidity	To IEC 721-3-3 Class 3K3 +1 ... +50 °C 5 ... 85 % rh (non-condensing)	
	Transport / Storage Environmental conditions Temperature Humidity	To IEC 721-3-2 Class 2K3 -25 ... +70 °C 95 % rh (non-condensing)	

		SFA21/18	SFA71/18
Industry standards	Meets the requirements for CE marking: EMC Directive Low Voltage Directive	89/336/EEC 73/23/EEC	
	Protection class	II to EN 60730 Section 2.7	III to EN 60730 Section 2.7
Dimensions / Weight	Housing protection standard	IP30 to DIN 40050, EN60529	
	Dimensions	See "Dimensions"	
	Weight		
	without auxiliary switch	0.585 kg	0.585 kg
with auxiliary switch	0.692 kg	0.692 kg	
Materials	Base-plate	Die-cast aluminum	
	Housing	Polycarbonate	
Housing colors	Base and cover	Light gray, RAL7035	
Auxiliary switch (optional)	Switch type	Changeover contact	
	Switching point	at approx. 50% stroke	
	Switching capacity	AC 250 V 1.0 A resistive 0.5 A inductive	
	Connecting cable	3-core, 1800 mm 18 AWG (0.96 mm ²)	

Connecting cable

Cable	SFA21/18 AC 230 V		SFA71/18 AC 24 V	
	Cable color	Connection	Cable color	Connection
Operating voltage 2-core	Brown	L	Red	G
	Blue	N	Black	G0
Auxil. switch ASC2.1/18 (optional) 3-core	Black / Red	Input	Black / Red	Input
	Black / Blue	N/C contact	Black / Blue	N/C contact
	Black / Pink	N/O contact	Black / Pink	N/O contact

Dimensions

All dimensions in mm

**Actuators without
auxiliary switch**
SFA21/18, SFA71/18

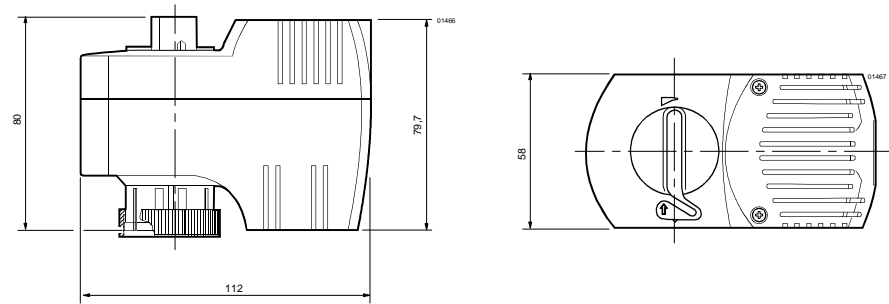

**Actuators with
auxiliary switches**
SFA21/18, SFA71/18
with ASC2.1/18

